

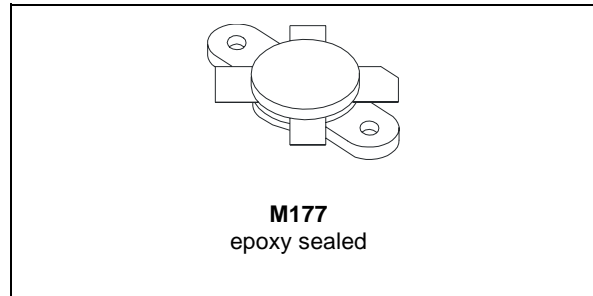

SD2933

RF POWER TRANSISTORS HF/VHF/UHF N-CHANNEL MOSFETs

- GOLD METALLIZATION
- EXCELLENT THERMAL STABILITY
- COMMON SOURCE CONFIGURATION
- $P_{OUT} = 300\text{ W MIN. WITH } 20\text{ dB GAIN @ } 30\text{ MHz}$
- THERMALLY ENHANCED PACKAGING FOR LOWER JUNCTION TEMPERATURES



DESCRIPTION

The SD2933 is a gold metallized N-Channel MOS field-effect RF power transistor. It is intended for use in 50 V dc large signal applications up to 150 MHz. Its special low thermal resistance package, makes it ideal for ISM applications where reliability and ruggedness are critical factors.

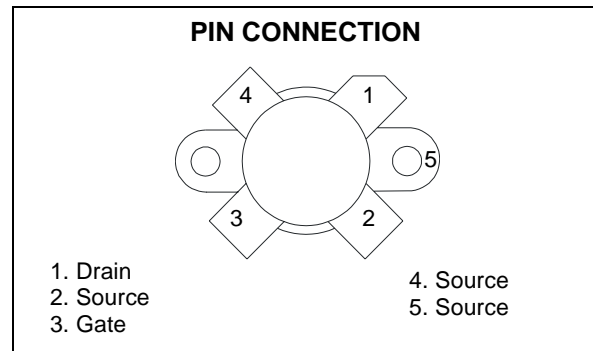

ORDER CODES

Order Codes	Marking	Package	Packaging
SD2933	SD2933	M177	Plastic Tray

ABSOLUTE MAXIMUM RATINGS ($T_{CASE} = 25\text{ }^{\circ}\text{C}$)

Symbol	Parameter	Value	Unit
$V_{(BR)DSS}$	Drain Source Voltage	125	V
V_{DGR}	Drain-Gate Voltage ($R_{GS} = 1\text{ M}\Omega$)	125	V
V_{GS}	Gate-Source Voltage	± 20	V
I_D	Drain Current	40	A
P_{DISS}	Power Dissipation	648	W
T_j	Max. Operating Junction Temperature	200	$^{\circ}\text{C}$
E_{AS}	Avalanche Energy, Single Pulse ($I_D = 60\text{ A}$)	1500	mJ
$E_{AR}^{(1)}$	Avalanche Energy, Repetitive	50	mJ
T_{STG}	Storage Temperature	-65 to +150	$^{\circ}\text{C}$

(1) Repetitive rating: Pulse width limited by maximum junction temperature
 Repetitive avalanche causes additional power losses that can be calculated as: $P_{AV} = E_{AR} * f$

THERMAL DATA

$R_{th(j-c)}$	Junction -Case Thermal Resistance	0.27	$^{\circ}\text{C/W}$
---------------	-----------------------------------	------	----------------------

ELECTRICAL SPECIFICATION ($T_{CASE} = 25^{\circ}C$)

STATIC

Symbol	Test Conditions		Min.	Typ.	Max.	Unit
$V_{(BR)DSS}$	$V_{GS} = 0\text{ V}$	$I_{DS} = 200\text{ mA}$	125			V
I_{DSS}	$V_{GS} = 0\text{ V}$	$V_{DS} = 50\text{ V}$			100	μA
I_{GSS}	$V_{GS} = 20\text{ V}$	$V_{DS} = 0\text{ V}$			500	nA
$V_{GS(Q)}$	$V_{DS} = 10\text{ V}$	$I_D = 250\text{ mA}$	1.5		4	V
$V_{DS(ON)}$	$V_{GS} = 10\text{ V}$	$I_D = 20\text{ A}$			3	V
G_{FS}	$V_{DS} = 10\text{ V}$	$I_D = 10\text{ A}$	10			mho
C_{ISS}	$V_{GS} = 0\text{ V}$	$V_{DS} = 50\text{ V}$		1000		pF
C_{OSS}	$V_{GS} = 0\text{ V}$	$V_{DS} = 50\text{ V}$		372		pF
C_{RSS}	$V_{GS} = 0\text{ V}$	$V_{DS} = 50\text{ V}$		29		pF

GFS sorts for each unit

DYNAMIC

Symbol	Test Conditions		Min.	Typ.	Max.	Unit
P_{OUT}	$V_{DD} = 50\text{ V}$	$I_{DQ} = 250\text{ mA}$ $f = 30\text{ MHz}$	300	400		W
G_{PS}	$V_{DD} = 50\text{ V}$	$I_{DQ} = 250\text{ mA}$ $P_{OUT} = 300\text{ W}$ $f = 30\text{ MHz}$	20	23.5		dB
η_D	$V_{DD} = 50\text{ V}$	$I_{DQ} = 250\text{ mA}$ $P_{OUT} = 300\text{ W}$ $f = 30\text{ MHz}$	50	65		%
Load Mismatch	$V_{DD} = 50\text{ V}$	$I_{DQ} = 250\text{ mA}$ $P_{OUT} = 300\text{ W}$ $f = 30\text{ MHz}$ All Phase Angles	3:1			VSWR

IMPEDANCE DATA

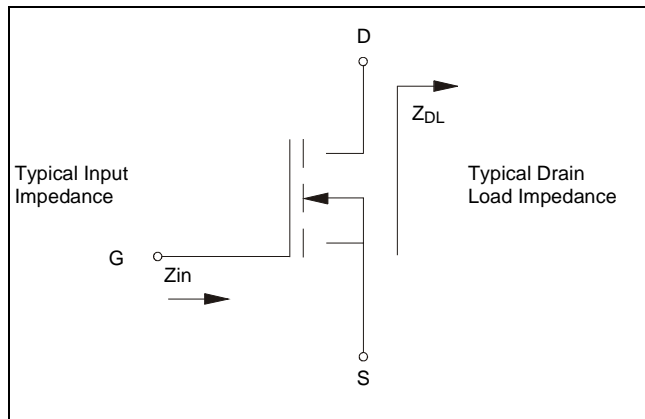

FREQ	$Z_{IN} (\Omega)$	$Z_{DL} (\Omega)$
30 MHz	$1.8 - j 0.2$	$2.8 + j 2.3$
108 MHz	$1.9 + j 0.2$	$1.6 + j 1.4$
175 MHz	$1.9 + j 0.3$	$1.5 + j 1.6$

GFS SORTS

A	10 ÷ 10.99	E	14 ÷ 14.99
B	11 ÷ 11.99	F	15 ÷ 15.99
C	12 ÷ 12.99	G	16 ÷ 16.99
D	13 ÷ 13.99	H	17 ÷ 18

TYPICAL PERFORMANCE

Capacitance vs. Drain-Source Voltage

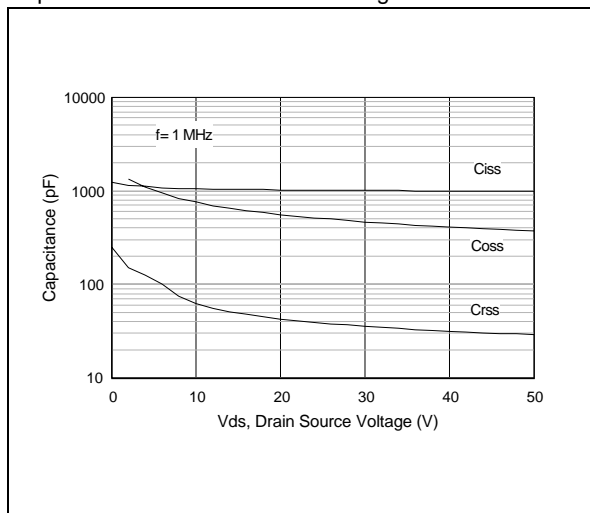

Drain Current vs. Gate Voltage

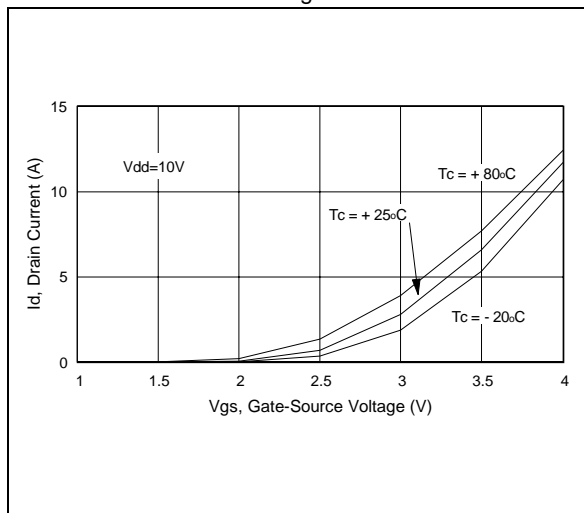

Gate-Source Voltage vs. Case Temperature

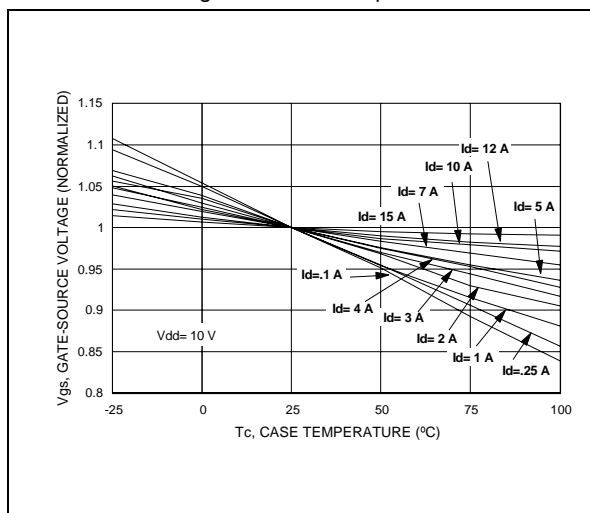

Maximum Thermal Resistance vs. Case Temperature

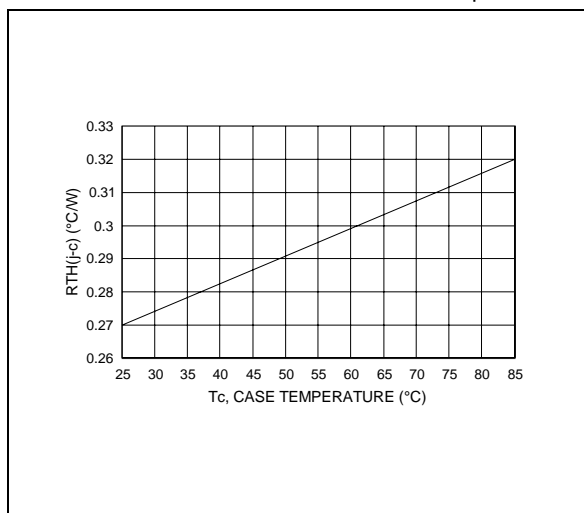

SD2933

TYPICAL PERFORMANCE

Output Power vs. Input Power

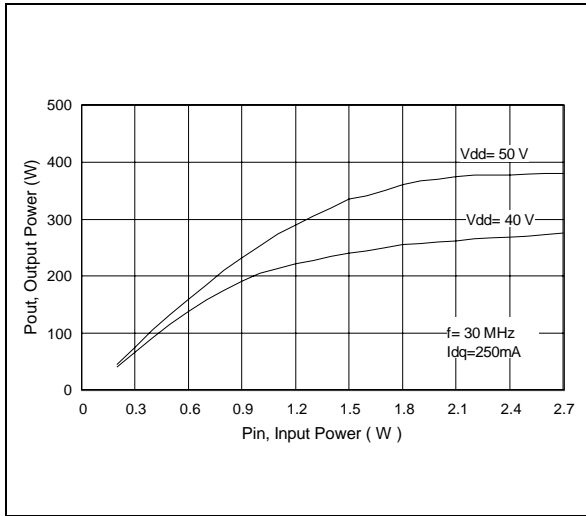

Output Power vs. Input Power

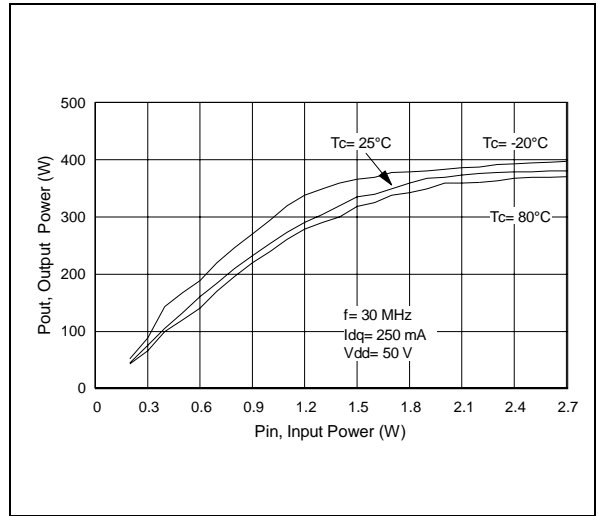

Power Gain vs. Output Power

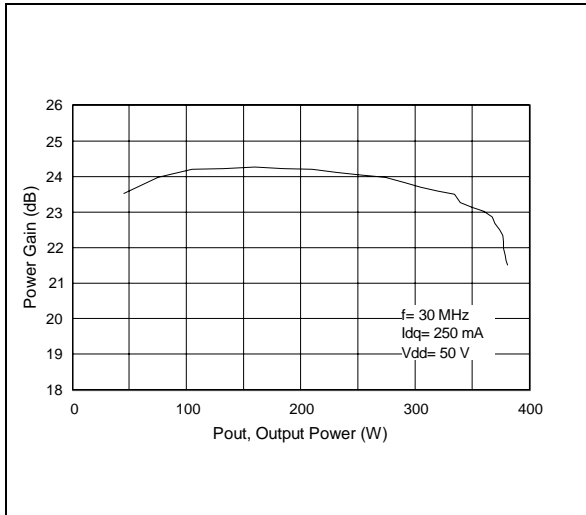

Efficiency vs. Output Power

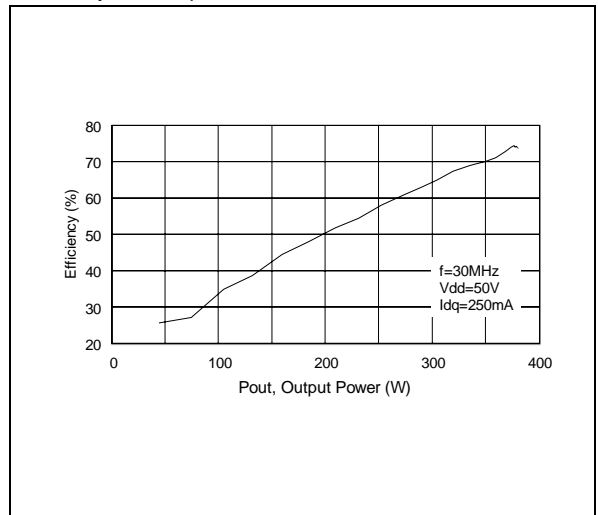

Output Power vs. Supply Voltage

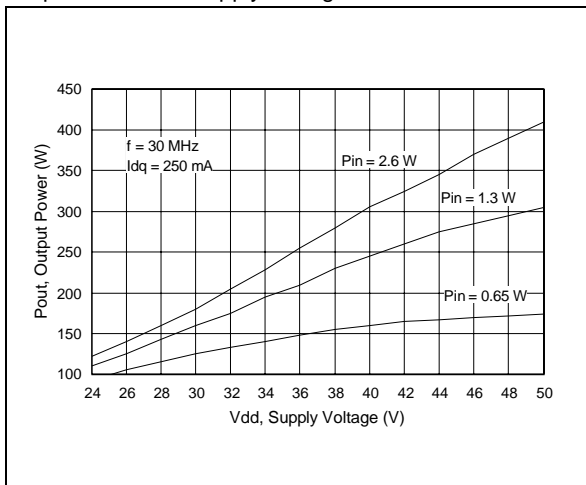

Output Power vs. Gate Voltage

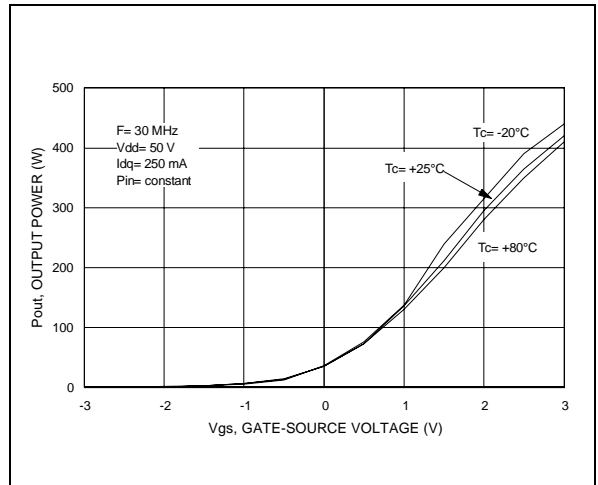

30 MHz Test Circuit Schematic

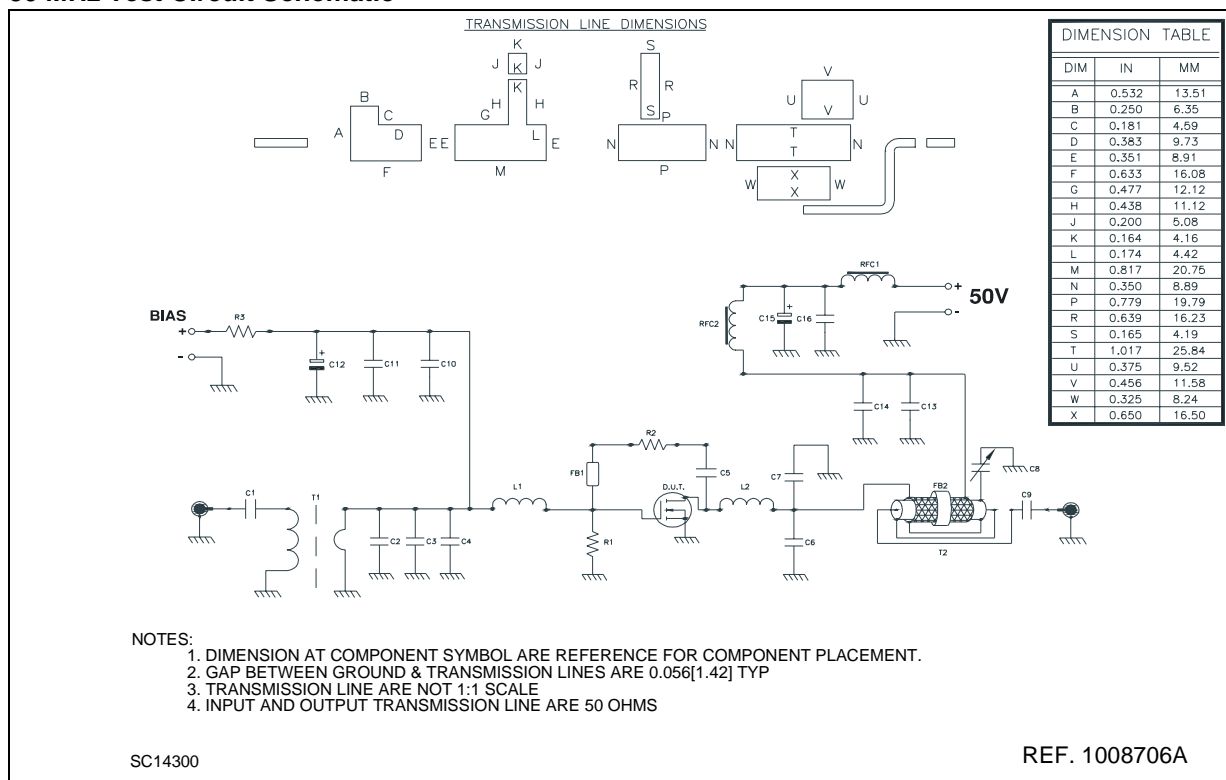

30 MHz Test Circuit Component Part List

C1,C9	0.01 μ F / 500 V SURFACE MOUNT CERAMIC CHIP CAPACITOR
C2, C3	750 pF ATC 700B SURFACE MOUNT CERAMIC CHIP CAPACITOR
C4	300 pF ATC 700B SURFACE MOUNT CERAMIC CHIP CAPACITOR
C5,C10,C11,C14,C16	10000 pF ATC 200B SURFACE MOUNT CERAMIC CHIP CAPACITOR
C6	510 pF ATC 700B SURFACE MOUNT CERAMIC CHIP CAPACITOR
C7	300 pF ATC 700B SURFACE MOUNT CERAMIC CHIP CAPACITOR
C8	175-680 pF TYPE 46 STANDARD TRIMMER CAPACITOR
C12	47 μ F / 63 V ALUMINUM ELECTROLYTIC RADIAL LEAD CAPACITOR
C13	1200 pF ATC 700B SURFACE MOUNT CERAMIC CHIP CAPACITOR
C15	100 μ F / 63 V ALUMINUM ELECTROLYTIC RADIAL LEAD CAPACITOR
R1,R3	1 K OHM 1 W SURFACE MOUNT CHIP RESISTOR
R2	560 OHM 2 W WIRE-WOUND AXIAL LEAD RESISTOR
T1	HF 2-30 MHz SURFACE MOUNT 9:1 TRANSFORMER
T2	RG - 142B/U 50 OHM COAXIAL CABLE OD = 0.165[4.18] L 15"[381.00] COVERED WITH 15"[381.00] TINNED COPPER TUBULAR BRAND 13/65" [5.1] WIDTH
L1	1 3/4 TURN AIR-WOUND 16 AWG ID = 0.219 [5.56] POLY-COATED MAGNET WIRE
L2	1 3/4 TURN AIR-WOUND 12 AWG ID = 0.250 [6.34] BUS BAR WIRE
RFC1,RFC2	3 TURNS 14 AWG WIRE THROUGH FAIR RITE TOROID
FB1	SURFACE MOUNT EMI SHIELD BEAD
FB2	TOROID
PCB	ULTRALAM 2000. 0.030" THK, $\epsilon_r = 2.55$, 2 Oz ED CU BOTH SIDES

30 MHz Test Circuit Photomaster

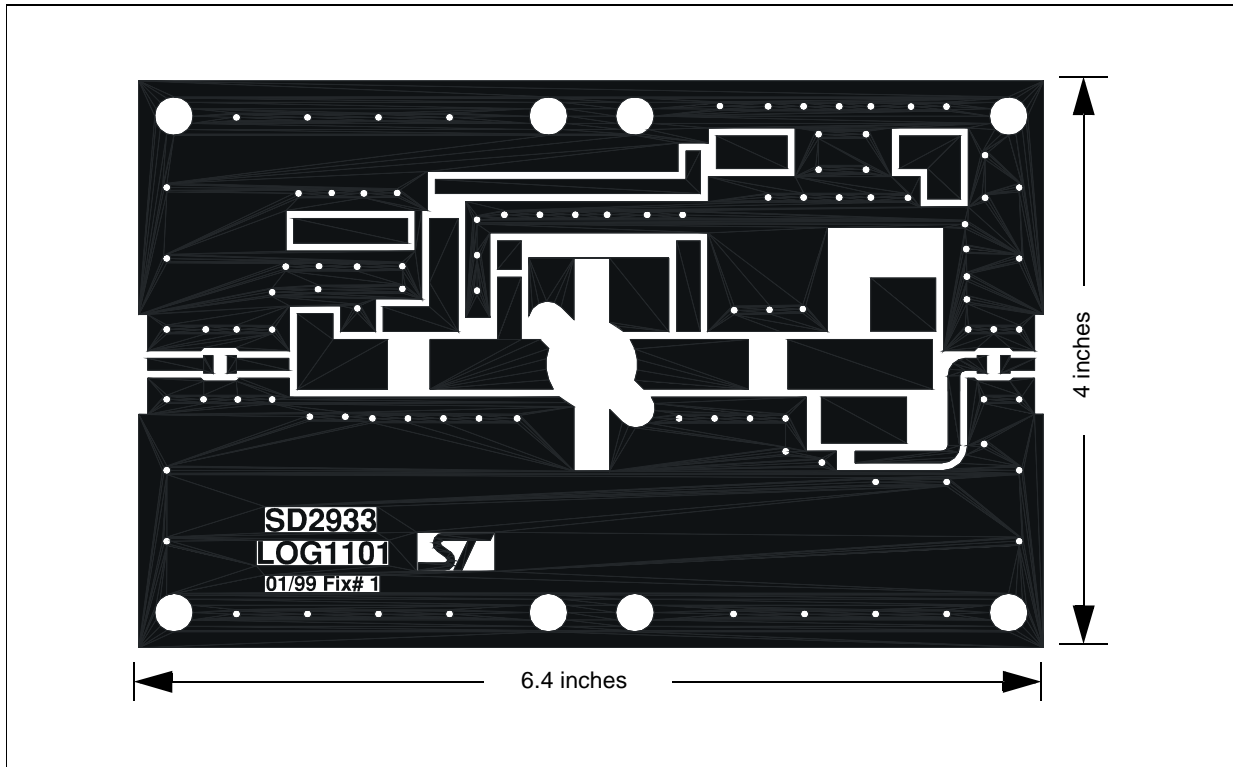

30 MHz Test Circuit

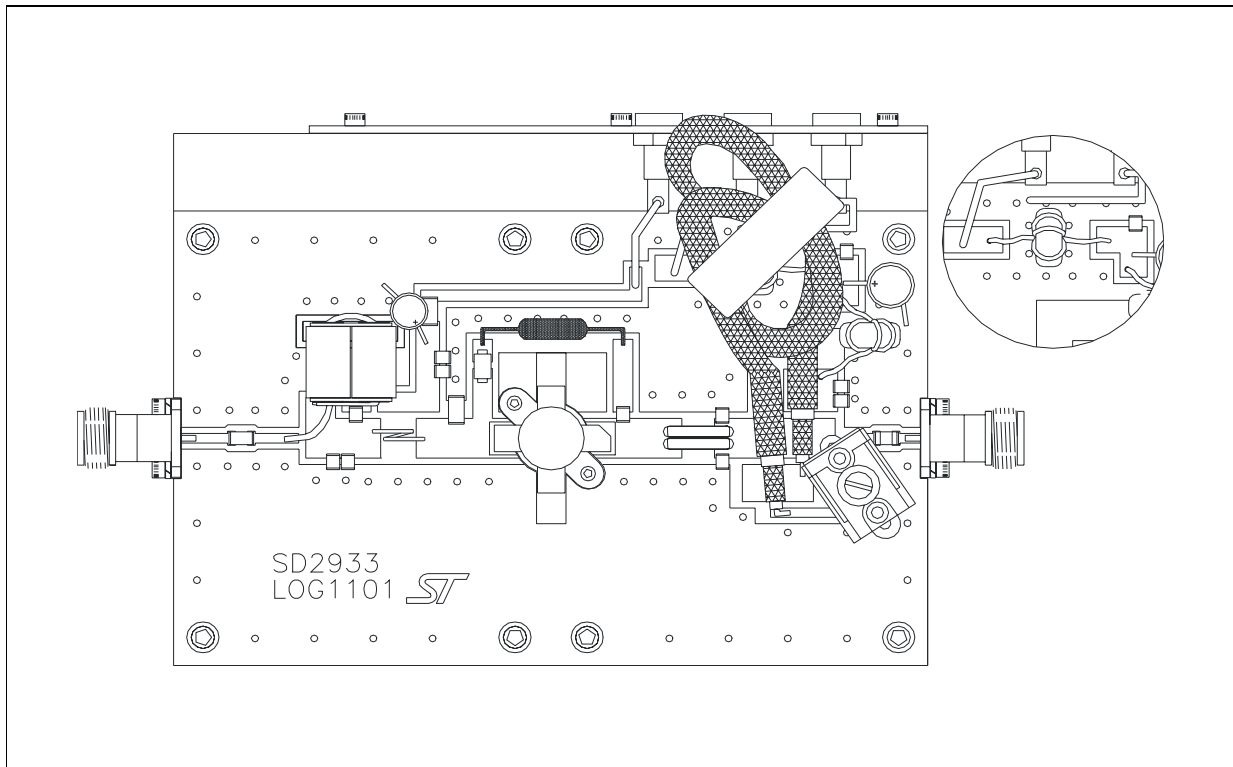

M177 (.550 DIA 4/L N/HERM W/FLG) MECHANICAL DATA

DIM.	mm			Inch		
	MIN.	TYP.	MAX	MIN.	TYP.	MAX
A	5.72		5.97	0.225		0.235
B	6.73		6.96	0.265		0.275
C	21.84		22.10	0.860		0.870
D	28.70		28.96	1.130		1.140
E	13.84		14.10	0.545		0.555
F	0.08		0.18	0.003		0.007
G	2.49		2.74	0.098		0.108
H	3.81		4.32	0.150		0.170
I			7.11			0.280
J	27.43		28.45	1.080		1.120
K	15.88		16.13	0.625		0.635

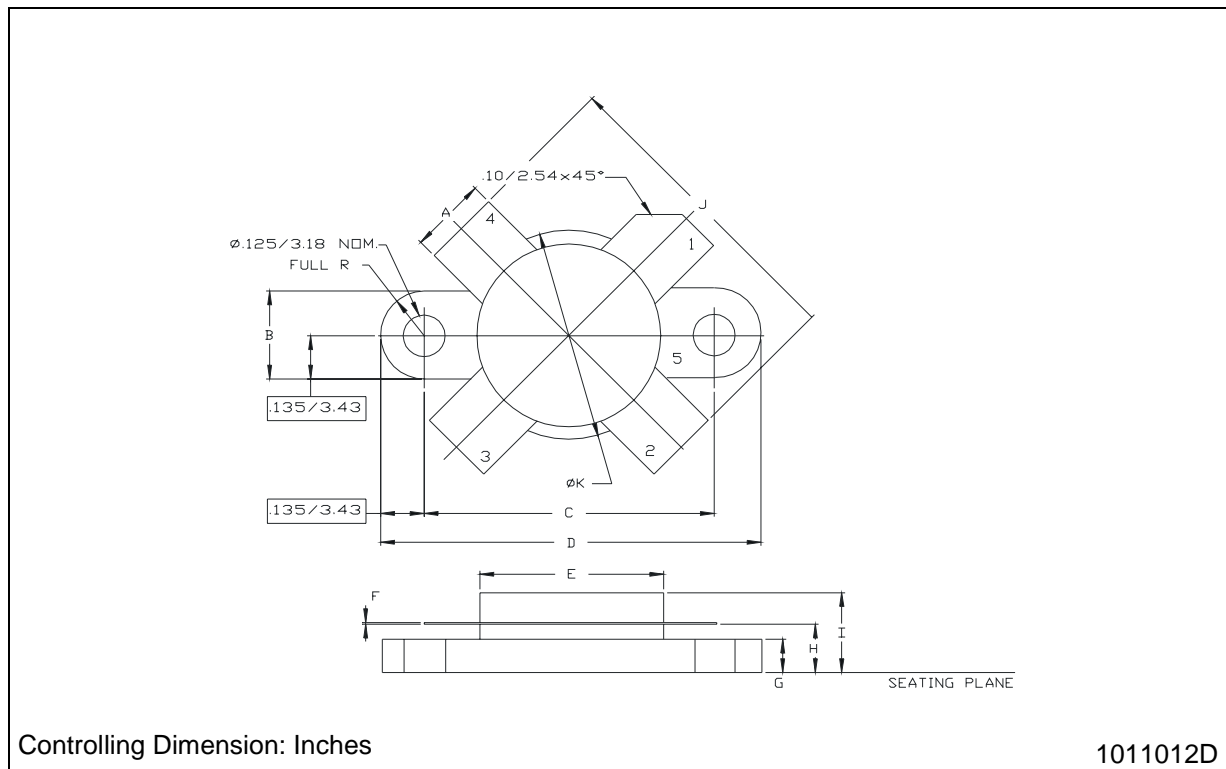

Information furnished is believed to be accurate and reliable. However, STMicroelectronics assumes no responsibility for the consequences of use of such information nor for any infringement of patents or other rights of third parties which may result from its use. No license is granted by implication or otherwise under any patent or patent rights of STMicroelectronics. Specifications mentioned in this publication are subject to change without notice. This publication supersedes and replaces all information previously supplied. STMicroelectronics products are not authorized for use as critical components in life support devices or systems without express written approval of STMicroelectronics.

The ST logo is registered trademark of STMicroelectronics
© 2004 STMicroelectronics - All Rights Reserved

All other names are the property of their respective owners.

STMicroelectronics GROUP OF COMPANIES
Australia - Belgium - Brazil - Canada - China - Czech Republic - Finland - France - Germany - Hong Kong - India - Israel - Italy - Japan -
Malaysia - Malta - Morocco - Singapore - Spain - Sweden - Switzerland - United Kingdom - United States

www.st.com